

# iwata

by ANEST IWATA



**IS875HT**



**IS925HT**

## OPERATING INSTRUCTION MANUAL



# NEED ASSISTANCE ?

If you have any issues or warranty service questions, contact your local ANEST IWATA affiliate before returning to your place of purchase.

**ANEST IWATA-MEDEA, INC.**

Portland, Oregon U.S.A.  
+1-503-253-7308 (M-F)  
info@iwata-medea.com  
www.iwata-airbrush.com

**ANEST IWATA SOUTH-EAST ASIA CO., LTD.**

Bangkok, Thailand  
+66-(0)-2643-2870  
www.anest-iwatasoutheastasia.com

**ANEST IWATA SOUTH AFRICA (PTY) LTD.**

Johannesburg, Republic of South Africa  
+27-11-463-2169/2265/2223  
www.anest-iwata.co.za

**ANEST IWATA CORPORATION**

Yokohama, Japan  
+81-(0)45-591-1111  
www.anest-iwata.co.jp

**ANEST IWATA STRATEGIC CENTER**

Cardano al Campo, Italy  
+39-0331-733120  
www.anest-iwataeu.com

**ANEST IWATA SHANGHAI**

Shanghai, China  
+86-(0)21-6407-9713 / 15 / 16  
www.anest-iwata-sh.com

**ANEST IWATA RUS LLC**

Moscow, Russia  
+7-495-938-77-28  
www.anestiwata.ru

**ANEST IWATA AUSTRALIA PTY LTD.**

Mt. Druitt, NSW  
+61-(02)-9853-2000  
www.anest-iwata.com.au

**ANEST IWATA (U.K.) LTD.**

Neots Cambs, England  
+44-(0)1480-405419  
www.anest-iwata.co.uk

**ANEST IWATA MOTHERSON LTD.**

Uttar Pradesh, India  
+91-(0)120-4600500 / 14 / 17  
www.anest-iwata.co.jp

**CENTURY TRADING CO., LTD.**

Seoul, Korea  
82-2-2163-0300  
www.centradng.co.kr

## FEATURES

### **The Carry Handle Is The Air Storage Tank**

#### **Oil-Less Piston Compressor**

Oil-less means oil-less. The compressor uses rubber gaskets to seal the compression chamber. This allows the compressor to be quiet without atomizing oil into the air stream, which makes the compressor virtually maintenance free.

#### **Air Pressure Regulator**

Fully adjustable air regulator for complete control of working pressure output.

#### **Moisture Trap Assembly**

The moisture trap filters out the water and debris down to 5 microns.

#### **Air Pressure Gauge**

Don't guess what pressure you're spraying at — know it! Your "working pressure" (or "working psi") is what the gauge shows while you have your trigger pressed down.

#### **Power Switch**

You don't have to unplug the compressor when you want it to stop, just flip the switch.

#### **Thermal Overload Switch**

If the compressor ever decides to overheat, the Thermal Overload Switch will turn off your compressor. If this switch cuts in, it's saving your compressor. Let it cool down. The switch will automatically reset itself.

#### **Voltage**

If you bought the compressor in the country you're going to use it, it's completely ready to go. If you're going to transfer the compressor to another country with a different voltage, you'll need a plug adapter and the appropriate power converter. **WARNING: Using a plug adapter and power converter may cause unit to overheat. Any issues resulting from the use of a power adapter and/or power converter are not covered under the Anest Iwata-Medea warranty.**

## EXPLODED DIAGRAM - SMART JET PLUS IS875HT

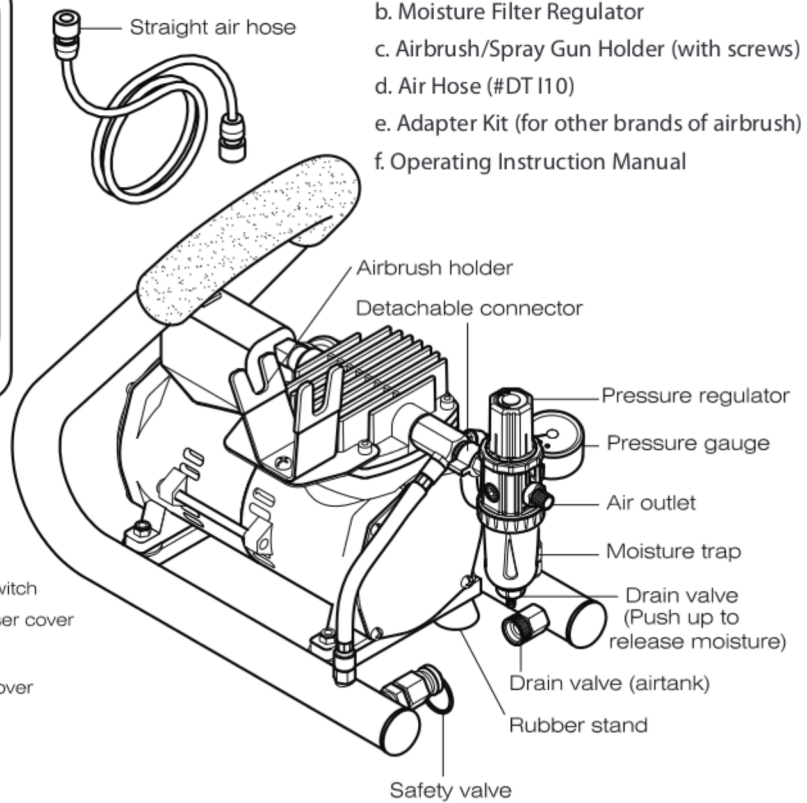
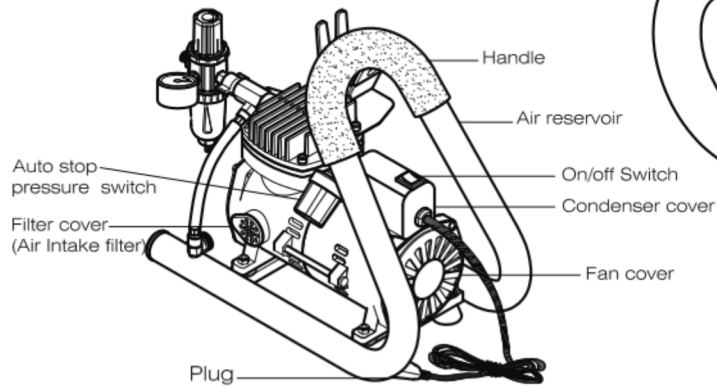
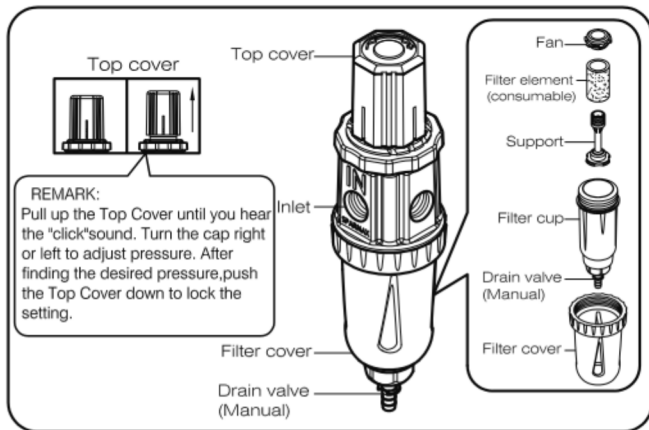

Unpack the compressor and all packaged components. Enclosed you'll find:

- Smart Jet Plus Compressor (#IS875HT)
- Moisture Filter Regulator
- Airbrush/Spray Gun Holder (with screws)
- Air Hose (#DT I10)
- Adapter Kit (for other brands of airbrush)
- Operating Instruction Manual

## EXPLODED DIAGRAM - POWER JET PLUS IS925HT

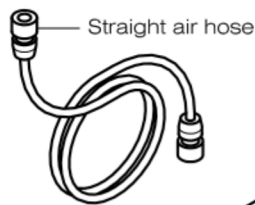
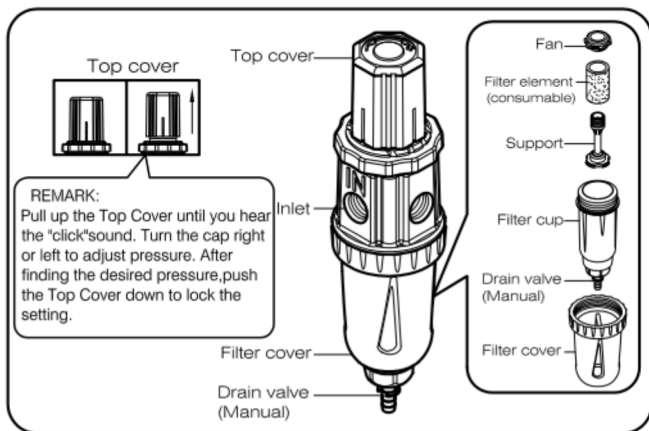

- Unpack the compressor and all packaged components. Enclosed you'll find:
- Power Jet Plus Compressor (#IS925HT)
  - Moisture Filter Regulator
  - Airbrush/Spray Gun Holder (with screws)
  - Air Hose (#DT 110)
  - Adapter Kit (for other brands of airbrush)
  - Operating Instruction Manual

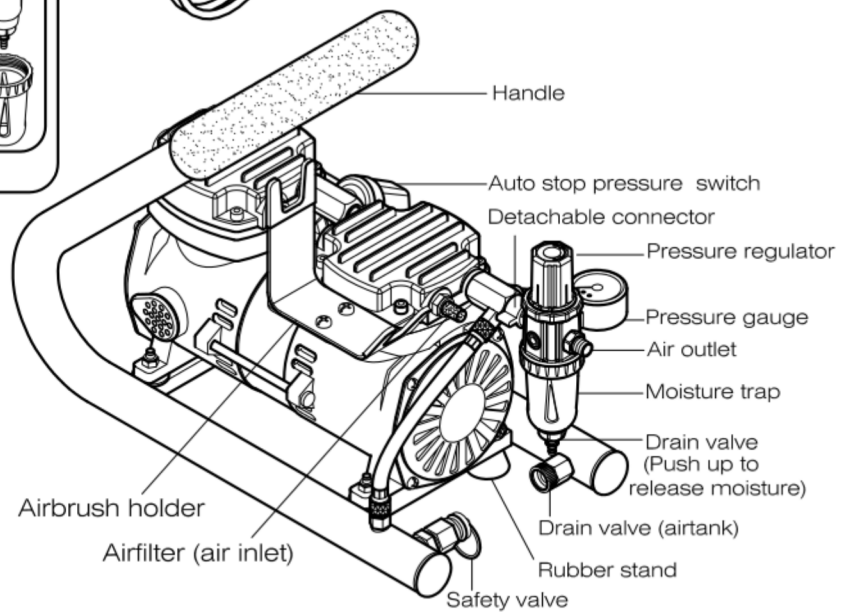
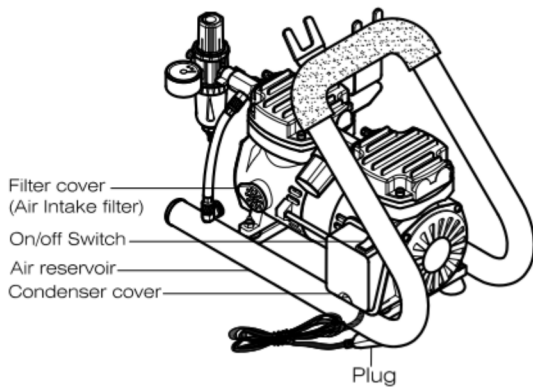

## GETTING STARTED

1. Screw the moisture filter regulator onto 1/4" fitting on compressor.
2. Screw airbrush/spray gun holder onto side metal plate with provided screws.
3. Screw the 1/8" fitting of the airbrush hose onto the airbrush. If you're using a brand of airbrush other than Iwata, use the appropriate adapter.
4. Screw the 1/4" fitting on the airbrush hose onto the compressor.
5. Plug the unit into a grounded electrical wall outlet that meets all local government specifications. Use only a grounded extension cord (minimum 16 AWG required).
6. Turn ON the unit by pressing the on/off switch. The compressor features automatic shut-off which means the unit will run until the storage tank fills up and then turns off. As the stored air depletes the unit will run to replenish the stored air.
7. Adjust the air pressure by turning the air pressure regulator. Turn knob toward "+" to increase pressure and toward "-" to decrease pressure. Push down on the knob to lock it in place and pull up to adjust.
8. When the airbrush is not in use it may be placed in the airbrush holder.

**NOTE ON MOISTURE:** Moisture will condense in the clear bowl of the moisture filter. To release this built-up moisture, use a paper towel and press up on the moisture drain valve at the bottom of the moisture filter. How often you need to do this will vary depending on humidity.

## ENDING A SESSION

1. Release any built up moisture in moisture filter.
2. Turn off the compressor.
3. Release any leftover air by pressing down on your airbrush trigger (being careful of any excess paint) or unscrewing your airbrush from the airhose.
4. The air storage tank will collect moisture and will need to be drained. How often is based on how much humidity is in the air. (Drain the tank after every use for optimal lifespan.)

## MAINTENANCE

### DRAINING MOISTURE FROM THE AIR STORAGE TANK

1. Turn off the compressor.
2. Depressurize the tank by releasing the remaining air in the tank. Air can be released through the airbrush or through the moisture drain valve.
3. Unscrew the nut from the air tank drain valve located on the back of the air storage tank.
4. Tip the compressor back and let it drain.
5. When it is finished draining, set compressor upright.
6. Screw the nut back into the air tank drain valve.

### RELEASING BUILT-UP MOISTURE IN THE MOISTURE FILTER

- Release moisture by pushing up on the moisture drain valve located underneath the moisture filter with a paper towel.
- For optimal performance, do not allow excess water build-up in the moisture filter.

### CHANGING THE AIR INTAKE FILTER

The filter only needs to be changed if it's significantly dirty or dirty enough to cut air flow into the compressor. Inspect your air intake filter once per week with heavy compressor use.

- Use your finger to pull out the filter cover and air intake filter.
- Remove the sponge-like air filter and replace with new air intake filter (IS012 – 10 pack).
- Push filter cover with new air intake filter back into place.



## TROUBLESHOOTING

### **COMPRESSOR TURNS ON AND OFF WHILE AIRBRUSH IS NOT SPRAYING AIR**

The compressor has an air leak. When this happens:

1. Spray all connections with a soapy water solution. Resulting bubbles indicate an air leak.
2. Tighten connections.
3. If bubbling doesn't stop, try wrapping threads with thread sealant tape (max 3 wraps only) or applying beeswax to the threads. Both methods provide an airtight seal.
4. If the air leak is in the middle of an airhose the hose will need to be replaced.

### **COMPRESSOR SUDDENLY TURNS OFF**

The thermal overload switch will turn off the compressor before it overheats. Allow unit to cool down. The switch will automatically reset itself.

### **FOR ANY OTHER PROBLEMS OR ISSUES**

Contact ANEST IWATA-MEDEA at 503-253-7308 or email at: [info@iwata-medea.com](mailto:info@iwata-medea.com)

## WARRANTY

All Iwata compressors are *Warranted* against all manufacturing defects of material and manufacture or workmanship for a period of ONE year from the date of purchase\*. This warranty does not cover intake air filters as periodic replacement of these parts is REQUIRED due to normal wear. Any part or material that is or becomes defective so as not to be usable within this period will be repaired or replaced. This warranty does not cover damage caused by negligence or a compressor that has been altered or abused in any way.

Call or email Anest Iwata-Medea before returning a compressor for the appropriate procedure for warranty repairs. Any material that is shipped to Anest Iwata-Medea without prior authorization will not be accepted.

- Anest Iwata-Medea offers technical support over the phone at no charge. **Call Customer Care at 503-253-7308 Monday – Friday, 8am – 4:30pm Pacific Time.** Telephone support includes general usage information, cleaning tips, and troubleshooting.
- **NOTE:** All compressors returned for repair must have a Return Authorization Number. **Please call 503-253-7308 to obtain an RA number**, instructions and shipping address.

Warranty service will be provided only at authorized Anest Iwata-Medea service centers. You must pay all charges for shipping/ transporting your Iwata compressor to/from these service facilities.

*Anest Iwata-Medea, Inc. will not be responsible for damage to persons or property, commercial loss or any other incidental or consequential damage caused by a defective compressor. However, some states do not allow the exclusion or limitation of incidental or consequential damages, so the above limitations may not apply to you.*

*All implied warranties, including any warranty of merchantability or fitness are limited to the duration of this written warranty. However, some states do not allow limitations on how long an implied warranty lasts, so the above limitation may not apply to you.*

*\* Please keep the sales receipt.*

*Genuine Iwata*



**iwata**  
by ANEST IWATA

**www.IWATA-AIRBRUSH.com**